

Embedding Words and Senses Together via Joint Knowledge-Enhanced Training

Presented in CoNLL 2017

Massimiliano Mancini*, José Camacho-Collados*, Ignacio Iacobacci and Roberto Navigli
Department of Computer Science, Sapienza University of Rome, Italy

Motivation

He withdrew money from the bank.

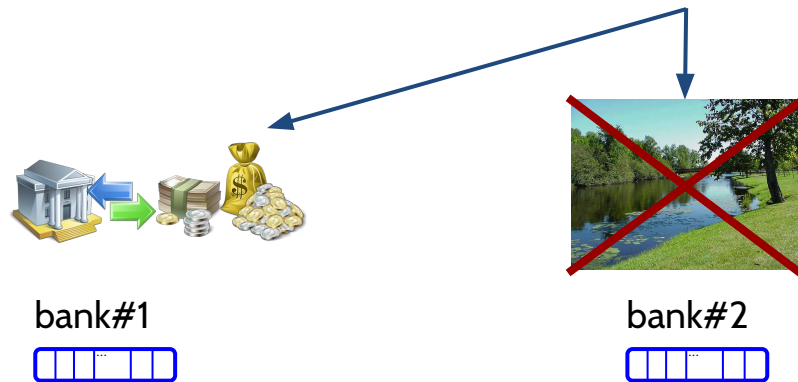

Linking words and senses in context

He withdrew money from the bank.

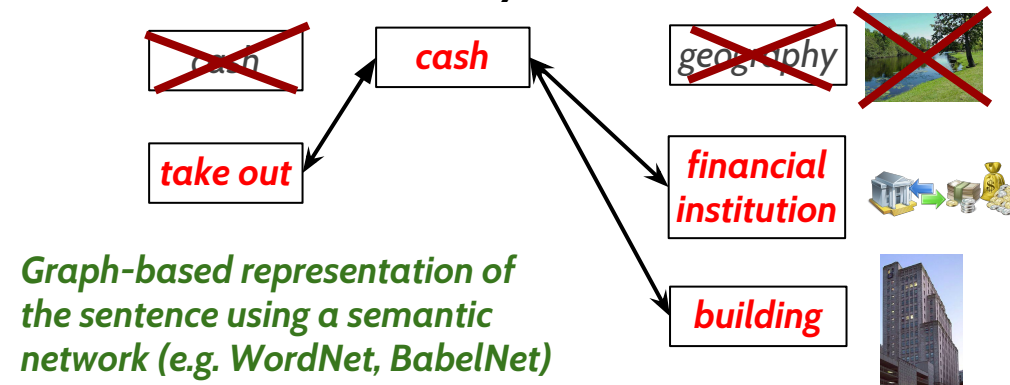

Evaluation

Word similarity

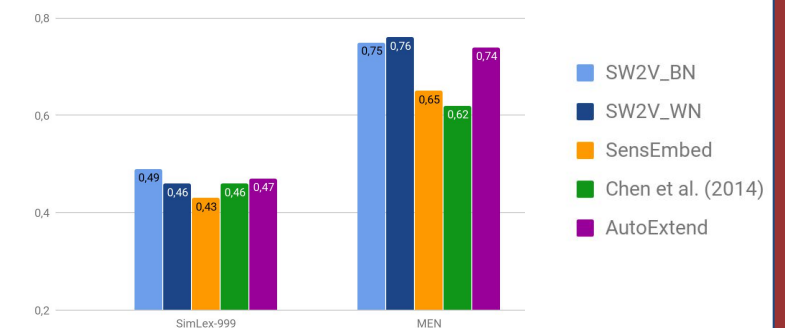

Sense clustering

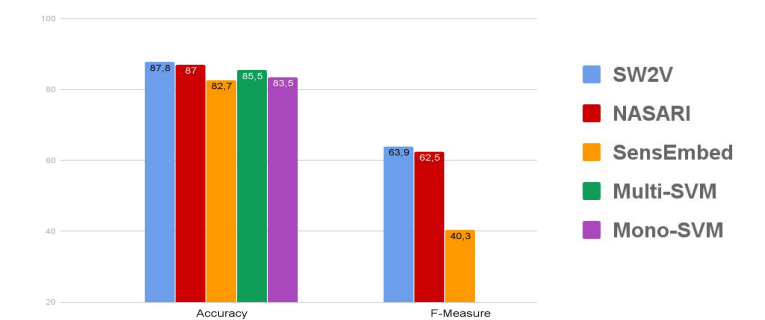

Methodology

Given as input a corpus and a semantic network:

1. Use a semantic network to link to each word its associated senses in context.
2. Use a neural network where the update of word and sense embeddings is linked, exploiting virtual connections.

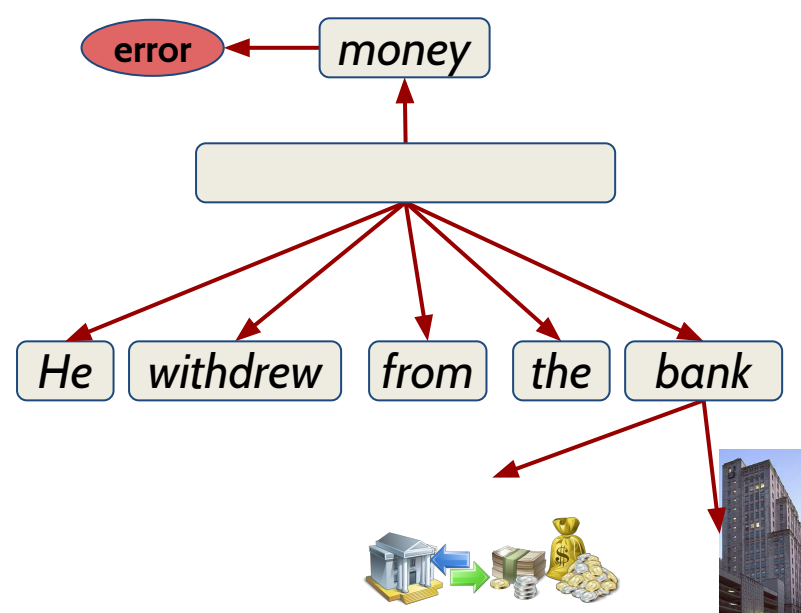

The Model

Full architecture of SW2V (this work)

$$E = -\log(p(w_t | W^t, S^t)) - \sum_{s \in S^t} \log(p(s | W^t, S^t))$$

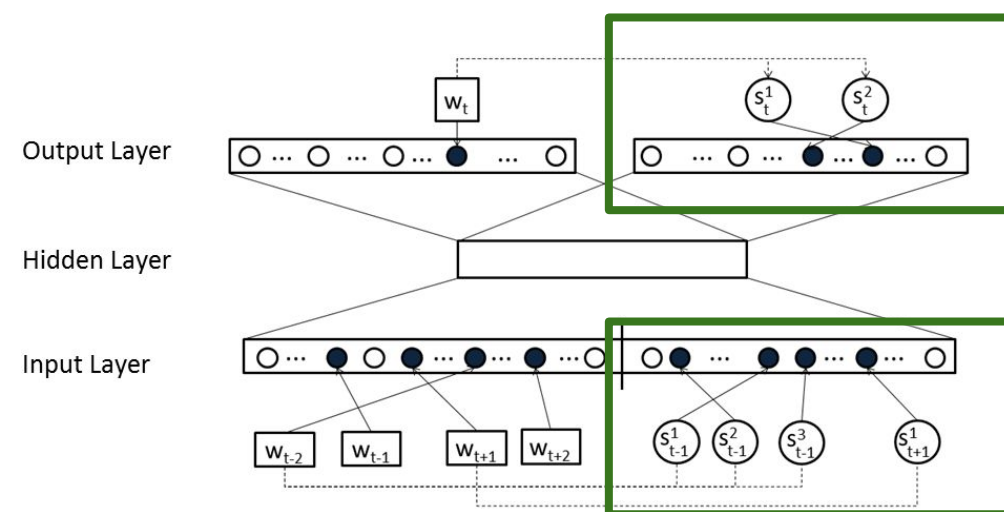

Word and sense interconnectivity

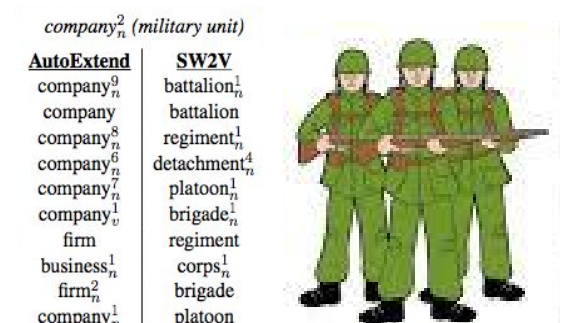
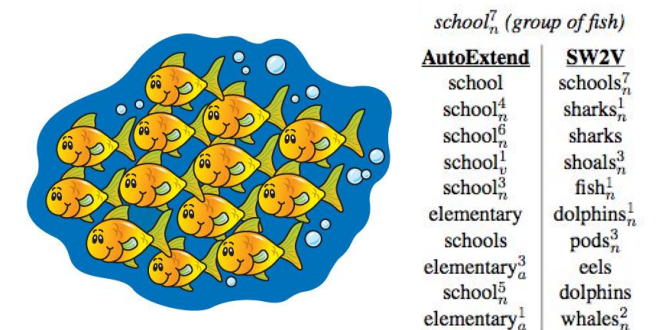

<http://lcl.uniroma1.it/sw2v>